

Atys-FS 180x85

**PREDINSTALACIJA
PREDINSTALACIJA
PREINSTALLATION
VORINSTALLATION**

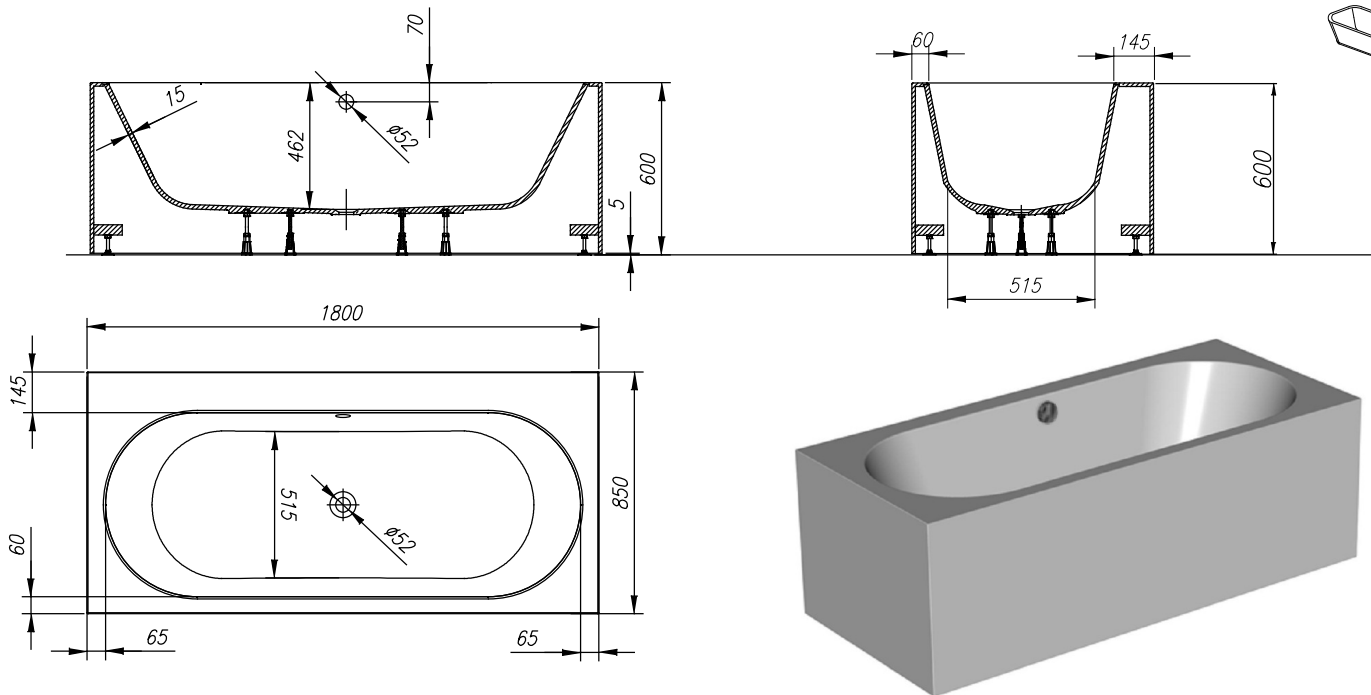

225 L

**VOLUMEN
VOLUMEN
VOLUME
VOLUMEN**



151 kg

**TEŽA
TEŽINA
WEIGHT
GEWICHT**

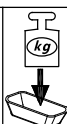

450 kg

**MAX. OBREMENITEV
MAX. OBTEREČENJE
MAX. LOAD
MAX. BELASTUNG**

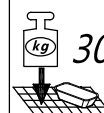

300 kg/m²

**OBREMENITEV TAL
OBTEREČENJE PODA
FLOOR LOAD
BODENBELASTUNG**

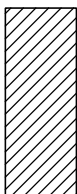

- Priklop tople in hladne vode 1/2", min 0,2 Mpa, max 0,4 Mpa
- Priključak tople i hladne vode 1/2", min 0,2 Mpa, max 0,4 Mpa
- Connection of hot and cold water 1/2", min 0,2Mpa, max 0,4Mpa
- Anschluss Warm- und Kaltwasser 1/2", min 0,2 Mpa, max 0,4 Mpa
- Prostor za odtok Ø 50 mm
- Mjesto za odtok Ø 50 mm
- Drain spot Ø 50mm
- Abflussplatz Ø 50 mm

*priporočilo za vgradnjo
preporuka za ugradnju
installation recommendation
Einbauempfehlung*

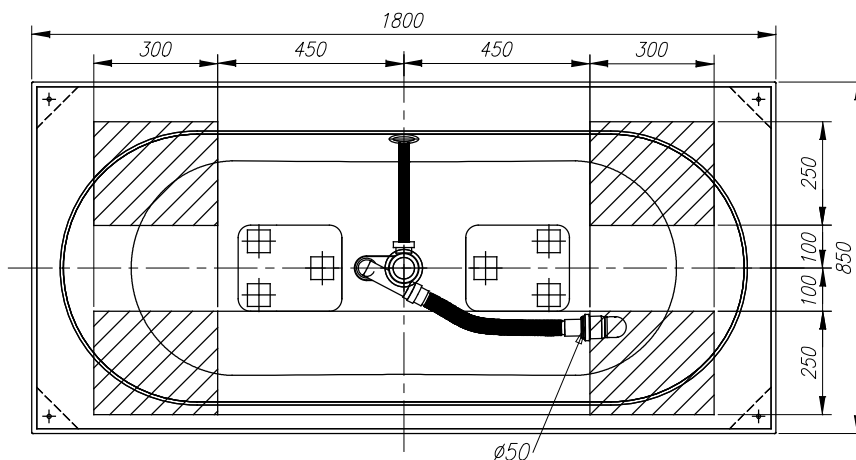

Samostoječa FS kopalna kad - navodilo za vgradnjo
FS samostoječa kada - upute za ugradnju
FS freestanding bathtub - installation instructions
FS Freistehende Badewanne - Einbauanleitung



Nr. MKKE 31

Kopalna kad iz KERROCK-a
Kada za kupanje iz KERROCK-a
Bathtub from KERROCK
Badewanne aus KERROCK

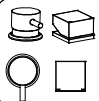

- MEŠALNI VENTIL TOPLA/HLADNA
 - VENTIL ZA MIEŠANJE TOPLO/HLADNO
 - MIXING VALVE HOT/COLD
 - MISCHVENTIL WARM/KALT

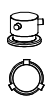

- PREKLOPNIK ROČNA PRHA/IZLIV
 - PREKIDAČ ZA RUČNI TUŠ/IZLJEV
 - HAND SHOWER/SPOUT SELECTOR SWITCH
 - SCHALTER FÜR HANDBRAUSE/AUSLAUF

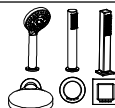

- ROČNA PRHA
 - RUČNI TUŠ
 - HAND SHOWER
 - HANDBRAUSE

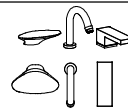

- IZLIV
 - IZLJEVNIK
 - SPOUT
 - AUSLAUF



- IZLIV NA PRELIVNI GARNITURI
 - IZLJEV NA PRELIVNOM SETU
 - SPOUT ON THE OVERFLOW SET
 - AUSLAUF AN DER ÜBERLAUFGARNITUR

- OPCIJA ENOROČNA ARMATURA WATERFALL
- OPCIJA JEDNORUČNA ARMATURA WATERFALL
- OPTION ONE HAND FITTING WATERFALL
- MÖGLICHKEIT EINWEG-ARMATUR WATERFALL

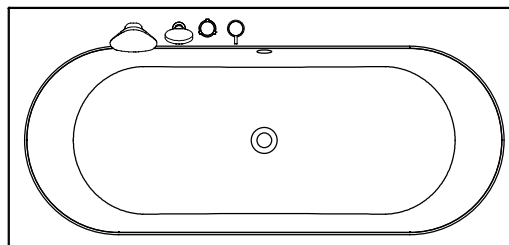
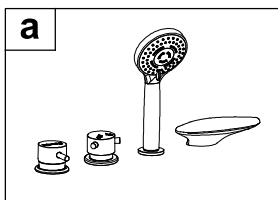

- OPCIJA ENOROČNA ARMATURA RAINDROP
- OPCIJA JEDNORUČNA ARMATURA RAINDROP
- OPTION ONE HAND FITTING RAINDROP
- MÖGLICHKEIT EINWEG-ARMATUR RAINDROP

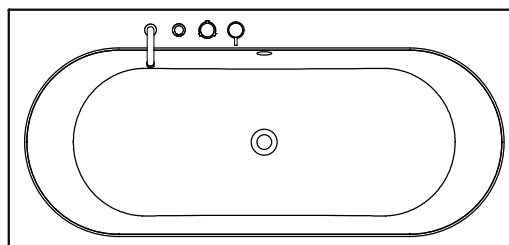
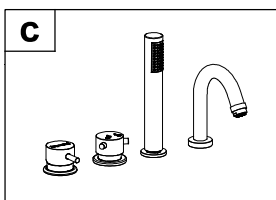

- OPCIJA ENOROČNA ARMATURA STREAM (CHR / BLACK)
- OPCIJA JEDNORUČNA ARMATURA STREAM (CHR / BLACK)
- OPTION ONE HAND FITTING STREAM (CHR / BLACK)
- MÖGLICHKEIT EINWEG-ARMATUR STREAM (CHR / BLACK)

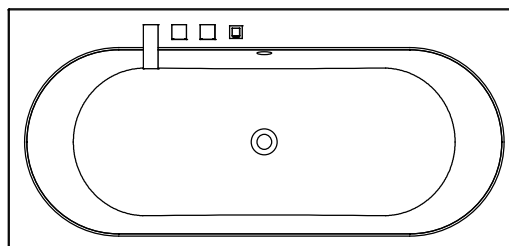
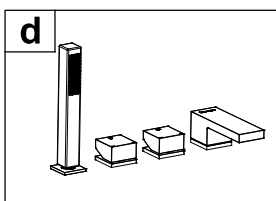

- Priklop tople in hladne vode 1/2", min 0,2 Mpa, max 0,4 Mpa
- Priključak tople i hladne vode 1/2", min 0,2 Mpa, max 0,4 Mpa
- Connection of hot and cold water 1/2", min 0.2Mpa, max 0.4Mpa
- Anschluss Warm- und Kaltwasser 1/2", min 0,2 Mpa, max 0,4 Mpa
- Prostor za odtok Ø 50 mm
- Mjesto za odtok Ø 50 mm
- Drain spot Ø 50mm
- Abflussplatz Ø 50 mm

priporočilo za vgradnjo
 preporuka za ugradnju
 installation recommendation
 Einbauempfehlung

